



US007835051B2

(12) **United States Patent**
Roichman et al.

(10) **Patent No.:** **US 7,835,051 B2**
(45) **Date of Patent:** **Nov. 16, 2010**

(54) **VOLUMETRIC IMAGING OF HOLOGRAPHIC OPTICAL TRAPS**

(75) Inventors: **Yohai Roichman**, New York, NY (US); **Ilias Cholis**, Brooklyn, NY (US); **David G. Grier**, New York, NY (US)

(73) Assignee: **New York University**, New York, NY (US)

(*) Notice: Subject to any disclaimer, the term of this patent is extended or adjusted under 35 U.S.C. 154(b) by 501 days.

(21) Appl. No.: **11/974,716**

(22) Filed: **Oct. 16, 2007**

(65) **Prior Publication Data**

US 2008/0094675 A1 Apr. 24, 2008

Related U.S. Application Data

(60) Provisional application No. 60/852,252, filed on Oct. 17, 2006.

(51) **Int. Cl.**
G02B 5/32 (2006.01)

(52) **U.S. Cl.** **359/15; 250/251**

(58) **Field of Classification Search** 359/1, 359/15; 250/251

See application file for complete search history.

(56) **References Cited**

U.S. PATENT DOCUMENTS

2003/0132373 A1* 7/2003 Curtis et al. 250/251
2005/0017161 A1* 1/2005 Grier et al. 250/251

OTHER PUBLICATIONS

Ashkin et al., "Observation of a Single-Beam Gradient Force Optical Trap for Dielectric Particles", *Optics Letters*, May 1986, pp. 288-290, vol. 11, No. 5, Optical Society of America.

Verma et al., "Entropic Colloidal Interactions in Concentrated DNA Solutions", *Physical Review Letters*, Nov. 2, 1998, pp. 4004-4007, vol. 81, No. 18, The American Physical Society.

Crocker et al., "Entropic Attraction and Repulsion in Binary Colloids Probed with a Line Optical Tweezer", *Physical Review Letters*, May 24, 1999, pp. 4352-5355, vol. 82, No. 21, The American Physical Society.

Verma et al., "Attractions Between Hard Colloidal Spheres in Semiflexible Polymer Solutions", *Macromolecules*, 2000, pp. 177-186, vol. 33, American Chemical Society.

Roichman et al., "Projecting Extended Optical Traps with Shape-Phase Holography", *Optics Letters*, Jun. 1, 2006, pp. 1675-1677, vol. 31, No. 11, Optical Society of America.

Roichman et al., "Optical Traps with Geometric Aberrations", *Applied Optics*, May 20, 2006, pp. 3425-3429, vol. 45, No. 15, Optical Society of America.

Dufresne et al., "Optical Tweezer Arrays and Optical Substrates Created with Diffractive Optics", *Review of Scientific Instruments*, May 1998, pp. 1974-1977, vol. 69, No. 5, American Institute of Physics.

(Continued)

Primary Examiner—Alessandro Amari

(74) *Attorney, Agent, or Firm*—Foley & Lardner LLP

(57) **ABSTRACT**

A method and system for manipulating object using a three dimensional optical trap configuration. By use of selected hologram on optical strap can be configured as a preselected three dimensional configuration for a variety of complex uses. The system can include various optical train components, such as partially transmissive mirrors and Keplerian telescope components to provide advantageously three dimensional optical traps.

14 Claims, 6 Drawing Sheets

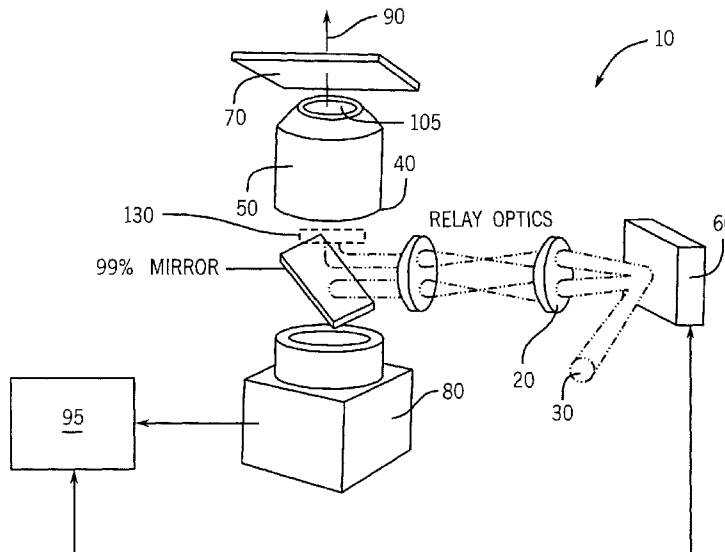

OTHER PUBLICATIONS

Polin et al., "Optimized Holographic Optical Traps", *Optics Express*, Jul. 25, 2005, pp. 5831-5845, vol. 13, No. 15, Optical Society of America.

Liesener et al., "Multi-Functional Optical Tweezers Using Computer-Generated Holograms", *Optics Communications*, Nov. 1, 2000, pp. 77-82, vol. 185, Elsevier Science B.V.

Roichman et al., "Holographic Assembly of Quasicrystalline Photonic Heterostructures", *Optics Express*, Jul. 11, 2005, pp. 5434-5439, vol. 13, No. 14, Optical Society of America.

Sasaki et al., "Pattern Formation and Flow Control of Fine Particles by Laser-Scanning Micromanipulation", *Optics Letters*, Oct. 1, 1991, pp. 1463-1465, vol. 16, No. 19, Optical Society of America.

Faucheux et al., "Optical Thermal Ratchet", *Physical Review Letters*, Feb. 27, 1995, pp. 1504-1507, vol. 74, No. 9, The American Physical Society.

Faucheux et al., "Periodic Forcing of a Brownian Particle", *Physical Review E*, Jun. 1995, pp. 5239-5250, vol. 51, No. 6, The American Physical Society.

Biancaniello et al., "Colloidal Interactions and Self-Assembly Using DNA Hybridization", *Physical Review Letters*, Feb. 11, 2005, pp. 058302-1-058302-4, vol. 94, The American Physical Society.

Moh et al., "Multiple Optical Line Traps Using a Single Phase-Only Rectangular Ridge", *Applied Physics B, Lasers and Optics*, 2005, pp. 973-976, vol. 80, Springer-Verlag.

Chiou et al., "Interferometric Optical Tweezers", *Optics Communications*, Jan. 1, 1997, pp. 7-10, vol. 133, Elsevier Science B.V.

Schonbrun et al., "3D Interferometric Optical Tweezers Using a Single Spatial Light Modulator", *Optics Express*, May 16, 2005, pp. 3777-3786, vol. 13, No. 10, OSA.

Yu et al., "The Manipulation and Assembly of CuO Nanorods with Line Optical Tweezers", *Nanotechnology*, 2004, pp. 1732-1736, vol. 15, IOP Publishing Ltd. UK.

Goodman, Joseph W., "Introduction to Fourier Optics", Second Edition, McGraw-Hill, 1996, New York.

Born et al., "Principles of Optics—Electromagnetic Theory of Propagation, Interference and Diffraction of Light", Seventh (Expanded) Edition, Cambridge University Press, 1999.

* cited by examiner

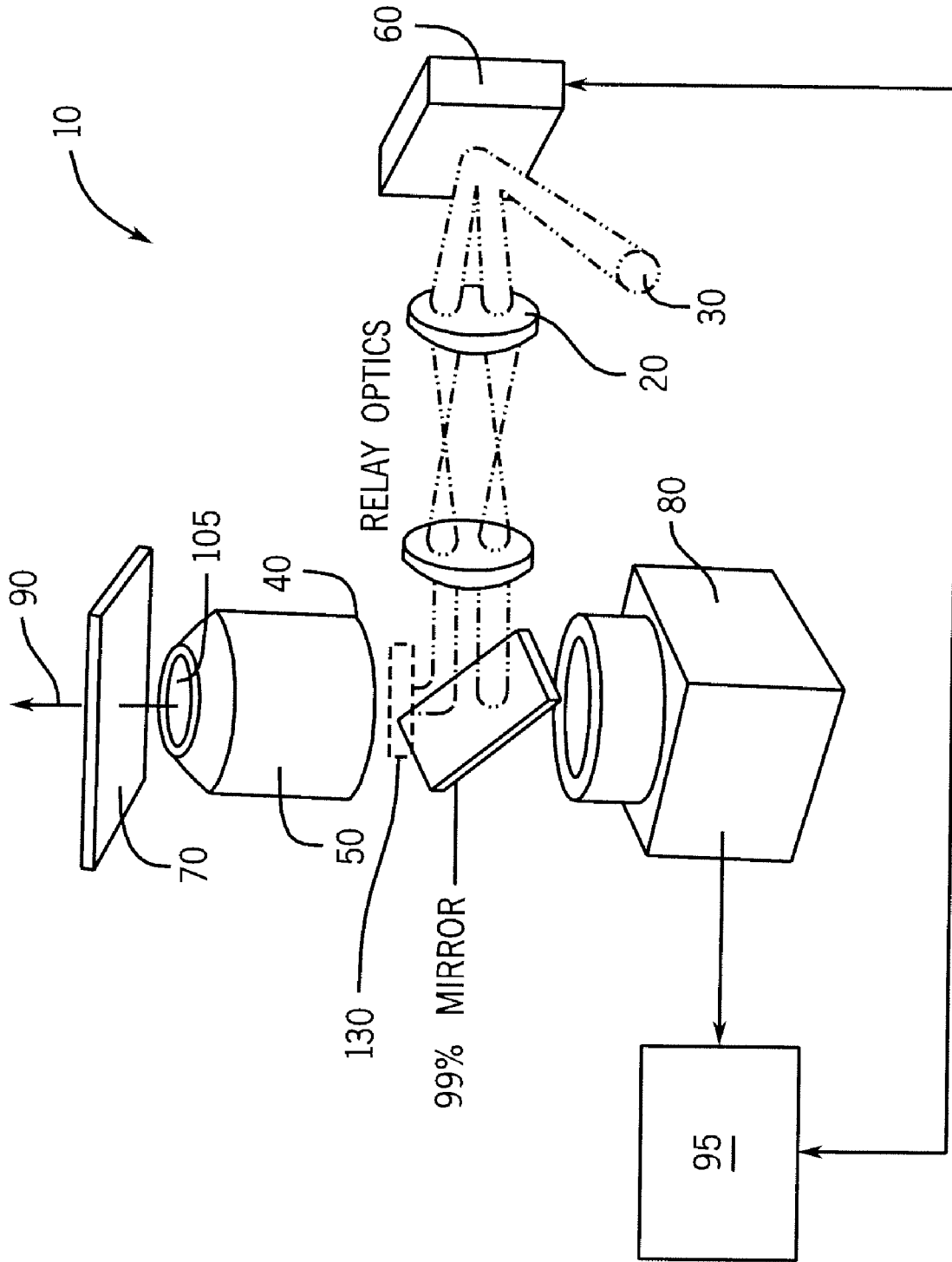

FIG. 1

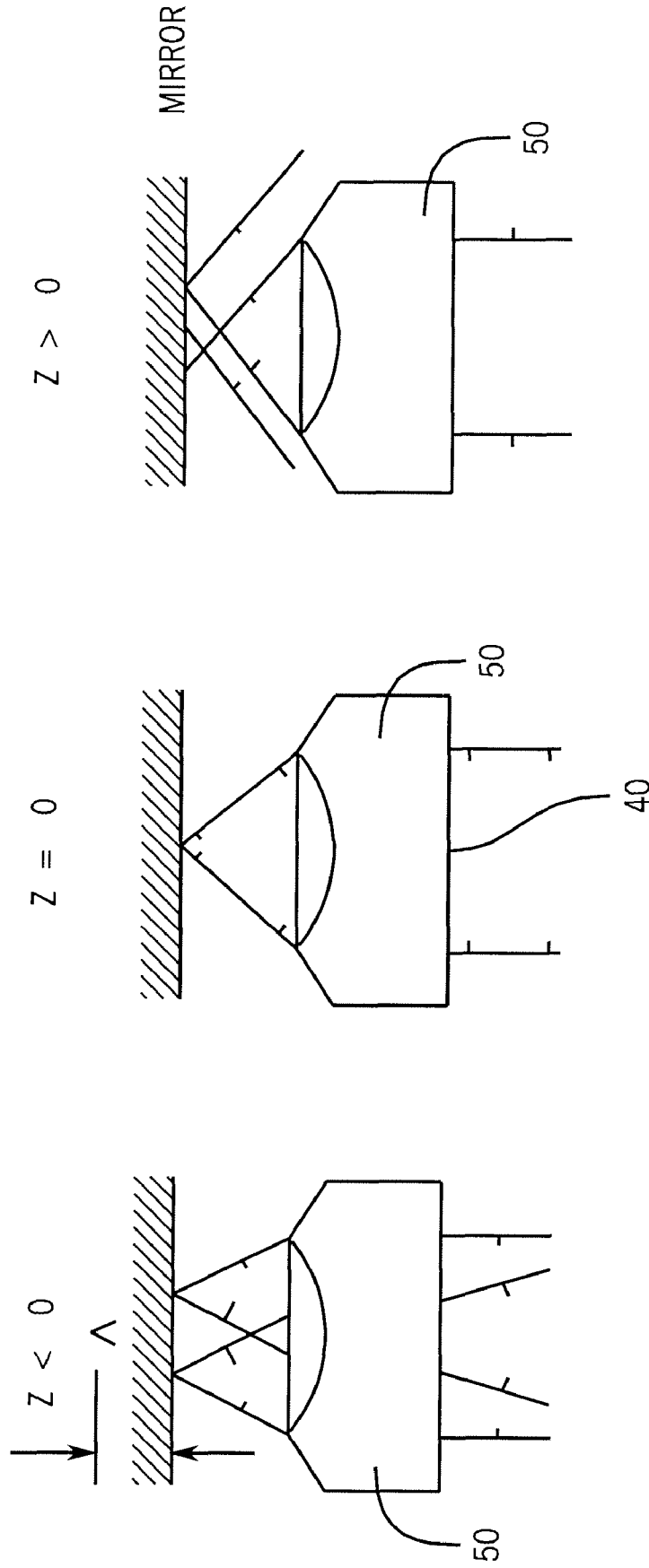

FIG. 2A

FIG. 2B

FIG. 2C

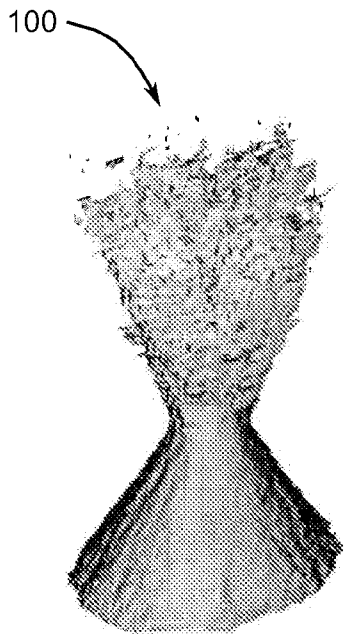

FIG. 3A

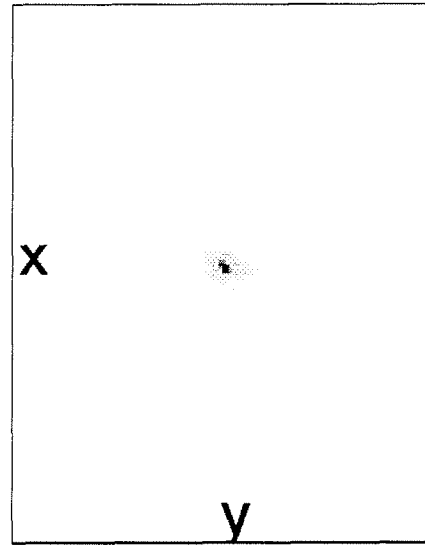

FIG. 3B

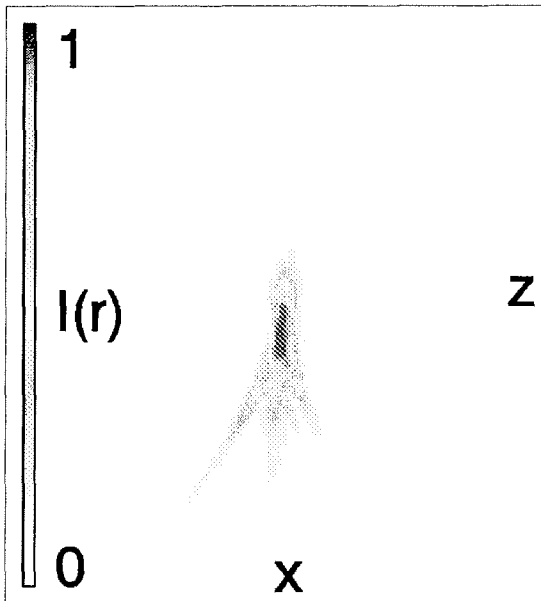

FIG. 3C

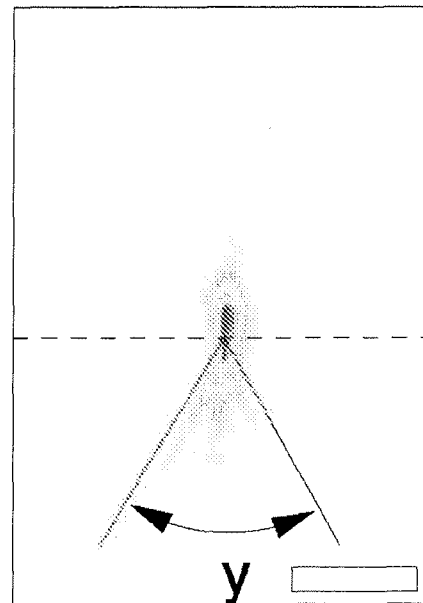

FIG. 3D

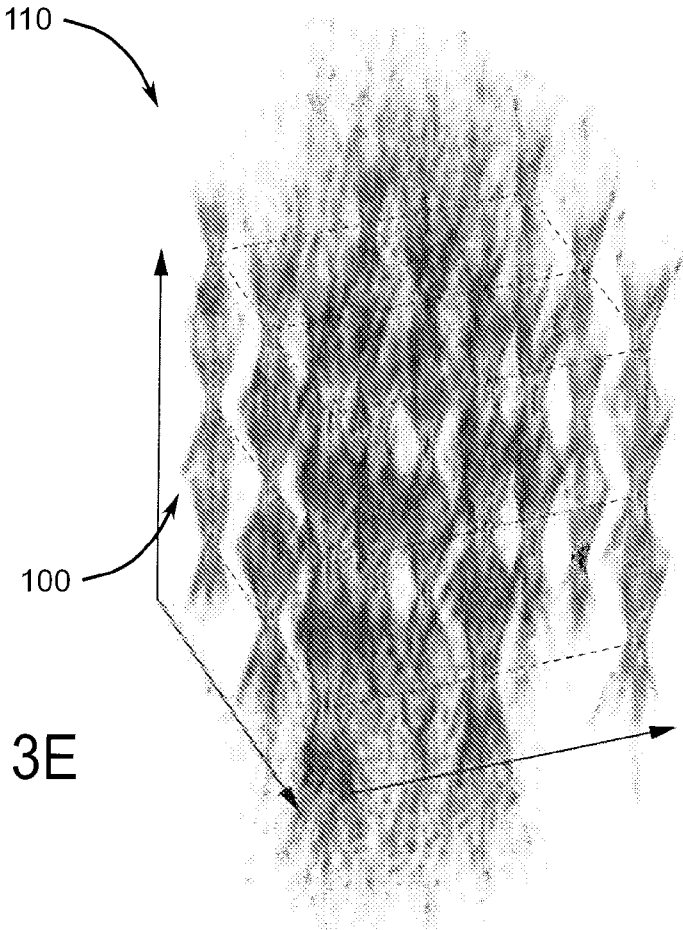

FIG. 3E

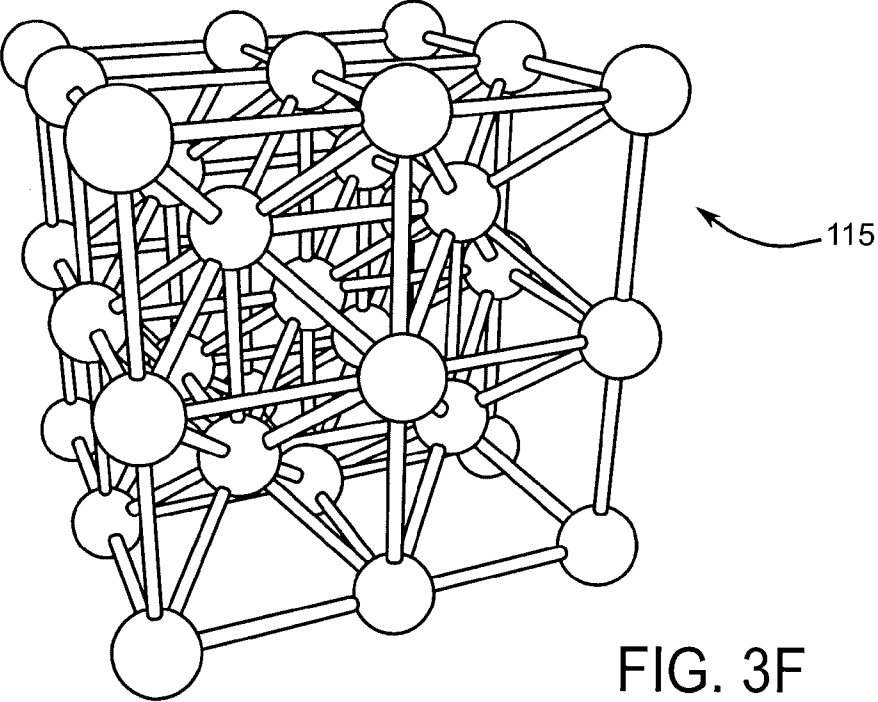

FIG. 3F



FIG. 4A

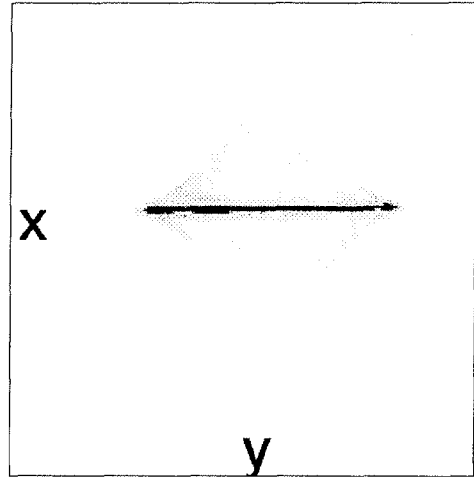

FIG. 4B

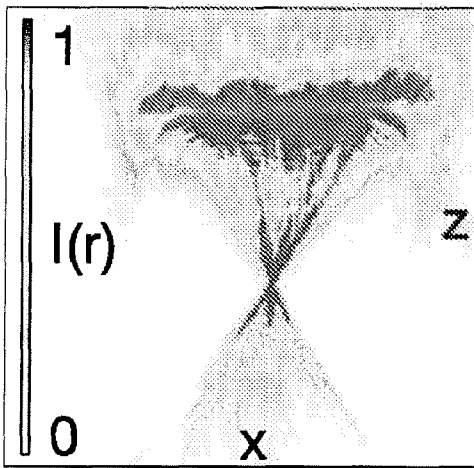

FIG. 4D

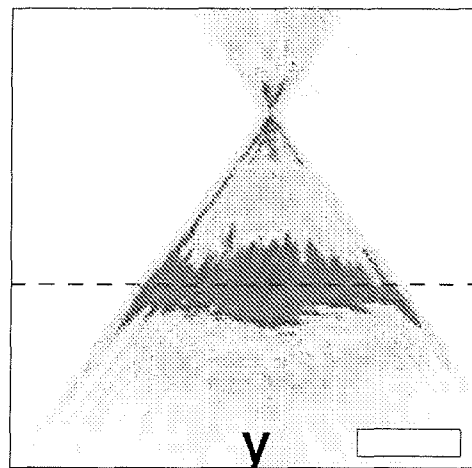

FIG. 4C



FIG. 5A

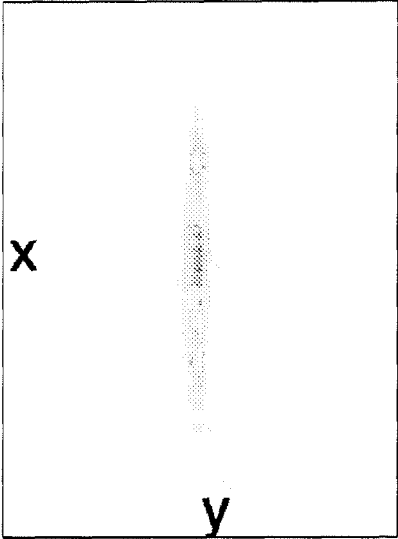

FIG. 5B

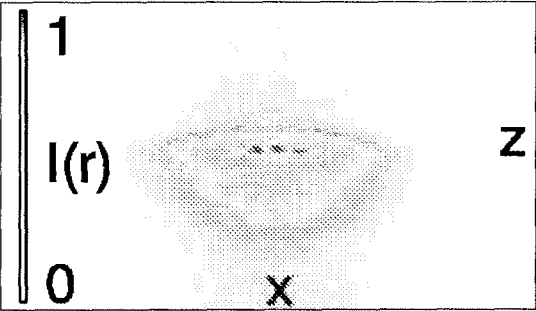

FIG. 5D

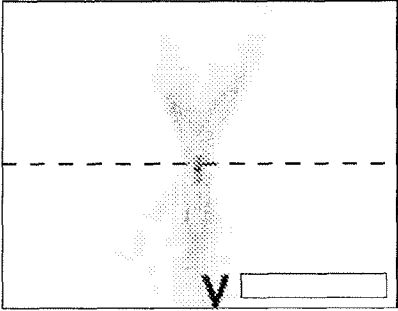

FIG. 5C

VOLUMETRIC IMAGING OF HOLOGRAPHIC OPTICAL TRAPS

CROSS-REFERENCE TO RELATED PATENT APPLICATIONS

This application claims the benefit under 35 USC 119(e) of U.S. Application No. 60/852,252, filed Oct. 17, 2006, incorporated herein by reference in its entirety.

The United States Government has certain rights in this invention pursuant to a grant from the National Science Foundation through grant number DMR-0451589.

This invention is directed toward volumetric imaging of holographic optical traps. More particularly, the invention is directed to a method and system for creating arbitrary pre-selected three-dimensional (3D) configurations of optical traps having individually specified optical characteristics. Holographic techniques are used to modify individual trap wavefronts to establish pre-selected 3D structures having predetermined properties and are positionable independently in three dimensional space to carry out a variety of commercially useful tasks.

BACKGROUND OF THE INVENTION

There is a well developed technology of using single light beams to form an optical trap which applies optical forces from the focused beam of light to confine an object to a particular location in space. These optical traps, or optical tweezers, have enabled fine scale manipulation of objects for a variety of commercial purposes. In addition, line traps, or extended optical tweezers, have been created which act as a one dimensional potential energy landscape for manipulating mesoscopic objects. Such line traps can be used to rapidly screen interactions between colloidal and biological particles which find uses in biological research, medical diagnostics and drug discovery. However, these applications require methods of manipulation for projecting line traps with precisely defined characteristics which prevent their use in situations with high performance demands. Further, the low degrees of freedom and facility of use for such line traps reduces the ease of use and limits the types of uses available.

SUMMARY OF THE INVENTION

The facility and range of applications of optical traps is greatly expanded by the method and system of the invention in which 3D intensity distributions are created by holography. These 3D representations are created by holographically translating optical traps through an optical train's focal plane and acquiring a stack of two dimensional images in the process. Shape phase holography is used to create a pre-selected 3D intensity distribution which has substantial degrees of freedom to manipulate any variety of object or mass for any task.

Various aspects of the invention are described hereinafter; and these and other improvements are described in greater detail below, including the drawings described in the following section.

BRIEF DESCRIPTION OF THE DRAWINGS

FIG. 1 illustrates an optical train for performing a method of the invention;

FIG. 2A illustrates a particular optical condition with $z < 0$ for an objective lens in the system of FIG. 1; FIG. 2B illus-

trates the optical condition for $z=0$ for the objective lens of FIG. 1 and FIG. 2C illustrates the optical condition for $z > 0$ for the objective lens of FIG. 1;

FIG. 3A illustrates a 3D reconstruction of an optical tweezer propagating along the z axis; FIG. 3B illustrates a cross-section of FIG. 3A along an xy plane; FIG. 3C illustrates a cross-section of FIG. 3A along a yz plane; FIG. 3D illustrates a cross-section of FIG. 3A along an xz plane; FIG. 3E illustrates a volumetric reconstruction of 35 optical tweezers arranged in a body-centered cubic lattice of the type shown in FIG. 3F;

FIG. 4A illustrates a 3D reconstruction of a cylindrical lens line optical tweezer; FIG. 4B illustrates a cross-section of FIG. 4A along an xy plane; FIG. 4C illustrates a cross-section of FIG. 4A along a yz plane; and FIG. 4D illustrates a cross-section of FIG. 4A along an xz plane; and

FIG. 5A illustrates a 3D reconstruction of a holographic optical trap featuring diffraction-limited convergence to a single focal plane; FIG. 5B illustrates a cross-section of FIG. 5A along a xy plane; FIG. 5C illustrates a cross-section of FIG. 5A along a yz plane; and FIG. 5D illustrates a cross-section of FIG. 5A along an xz plane.

DETAILED DESCRIPTION OF PREFERRED EMBODIMENTS

An optical system for performing methods of the invention is illustrated generally at **10** in FIG. 1. A beam of light **20** is output from a frequency-doubled solid-state laser **30**, preferably a Coherent Verdi system operating at a wavelength of $\lambda=532$ nm. The beam of light **20** is directed to an input pupil **40** of a high-numerical-aperture objective lens **50**, preferably a Nikon 100 x Plan Apo, NA 1.4, oil immersion system that focuses the beam of light **20** into an optical trap (not shown). The beam of light **20** is imprinted with a phase-only hologram by a computer-addressed liquid-crystal spatial light modulator **60** ("SLM **60**"), preferably a Hamamatsu X8267 PPM disposed in a plane conjugate to the objective lens' **50** input plane. Computer **95** executes conventional computer software to generate the appropriate hologram using the SLM **60**. As a result, the light field, $\psi(r)$, in the objective lens' **50** focal plane is related to the field $\psi(\rho)$ in the plane of the SLM **60** by the Fraunhofer transform,

$$\psi(r) = -\frac{i}{\lambda f} \int_{\Omega} \psi(\rho) \exp\left(-i\frac{2\pi}{\lambda f} r \cdot \rho\right) d^2\rho, \quad (1)$$

where f is the objective's focal length, where Ω is the optical train's aperture, and where we have dropped irrelevant phase factors. Assuming that the beam of light **20** illuminates the SLM **60** with a radially symmetric amplitude profile, $u(\rho)$, and uniform phase, the field in the SLM's plane may be written as,

$$\psi(\rho) = u(\rho) \exp(i\phi(\rho)), \quad (2)$$

where $\phi(\rho)$ is the real-valued phase profile imprinted on the beam of light **20** by the SLM **60**. The SLM **60** in our preferred form of the system **10** imposes phase shifts between 0 and 2π radians at each pixel of a 768×768 array. This two-dimensional phase array can be used to project a computer-generated phase-only hologram, $\phi(\rho)$, designed to transform the single optical tweezer into any desired three-dimensional configuration of optical traps, each with individually specified intensities and wavefront properties.

Ordinarily, the pattern of holographic optical traps would be put to use by projecting it into a fluid-borne sample mounted in the objective lens' **50** focal plane. To characterize the light field, we instead mount a front-surface mirror **70** in the sample plane. This mirror **70** reflects the trapping light back into the objective lens **50**, which transmits images of the traps through the partially reflecting mirror **70** to a charge-coupled device (CCD) camera **80**, preferably a NEC TI-324AII. In our implementation, the objective lens **50**, the camera **80** and camera eyepiece (not shown), are mounted in a conventional optical microscope (not shown) and which is preferably a Nikon TE-2000U.

Three-dimensional reconstructions of the optical traps' intensity distribution can be obtained by translating the mirror **70** relative to the objective lens **50**. Equivalently, the traps can be translated relative to the mirror **70** by superimposing the parabolic phase function,

$$\varphi_z(\rho) = -\frac{\pi\rho^2 z}{\lambda f^2}, \quad (3)$$

onto the hologram $\phi_0(\rho)$ encoding a particular pattern of traps. The combined hologram, $\phi_0(\rho) = \phi_0(\rho) + \phi_z(\rho) \bmod 2\pi$, projects the same pattern of traps as $\phi_0(\rho)$ but with each trap translated by $-z$ along optical axis **90** of the system **10**. The resulting image obtained from the reflected light represents a cross-section of the original trapping intensity at distance z from the focal plane of the objective lens **50**. Translating the traps under software control by computer **95** is particularly convenient because it minimizes changes in the optical train's properties due to mechanical motion and facilitates more accurate displacements along the optical axis **90**. Images obtained at each value of z are stacked up to yield a complete volumetric representation of the intensity distribution.

As shown schematically in FIGS. **2A-2C**, the objective lens **50** captures essentially all of the reflected light for $z < 0$. For $z > 0$, however, the outermost rays of the converging trap are cut off by the objective lens' **50** output pupil **105**, and the contrast is reduced accordingly. This could be corrected by multiplying the measured intensity field by a factor proportional to z for $z > 0$. The appropriate factor, however, is difficult to determine accurately, so we present only unaltered results.

FIG. **3A** shows a conventional optical tweezer **100** reconstructed in the manner described hereinbefore and displayed as an iso-intensity surface at 5 percent peak intensity and in three cross-sections (FIGS. **3B-3D**). The representation in FIG. **3A** is useful for showing the overall structure of the converging light, and the cross-sections of FIGS. **3B-3D** provide an impression of the three dimensional light field that will confine an optically trapped object. The angle of convergence of 63° in immersion oil obtained from these data is consistent with an overall numerical aperture of 1.4. The radius of sharpest focus, $r_{min} \approx 0.2 \mu\text{m}$, is consistent with diffraction-limited focusing of the beam of light **20**.

These results highlight two additional aspects of this reconstruction technique. The objective lens **50** is designed to correct for spherical aberration when the beam of light **20** passing through water is refracted by a glass coverslip. Without this additional refraction, the projected optical trap **100** actually is degraded by roughly 20λ of spherical aberration, introduced by the objective lens **50**. This reduces the apparent numerical aperture and also extends the trap's focus along the z axis. The trap's effective numerical aperture in water would be roughly 1.2. The effect of spherical aberration can be

approximately corrected by pre-distorting the beam of light **20** with the additional phase profile,

$$\varphi_\alpha(\rho) = \frac{\alpha}{\sqrt{2}}(6x^4 - 6x^2 + 1), \quad (4)$$

the Zernike polynomial describing spherical aberration. The radius, x , is measured as a fraction of the optical train aperture, and the coefficient α is measured in wavelengths of light. This procedure is used to correct for small amount of aberration present in practical optical trapping systems to optimize their performance.

This correction was applied to an array **110** of 35 optical tweezers shown as a three-dimensional reconstruction in FIG. **3E**. These optical traps **100** are arranged in a three-dimensional body-centered cubic (BCC) lattice **115** shown in FIG. **3F** with a $10.8 \mu\text{m}$ lattice constant. Without correcting for spherical aberration, these traps **100** would blend into each other along the optical axis **90**. With correction, their axial intensity gradients are clearly resolved. This accounts for holographic traps' ability to organize objects along the optical axis.

Correcting for aberrations reduces the range of displacements, z , that can be imaged. Combining $\phi_\alpha(\rho)$ with $\phi_z(\rho)$ and $\phi_0(\rho)$ increases gradients in $\phi(\rho)$, particularly for larger values of ρ near the edges of the diffraction optical element. Diffraction efficiency falls off rapidly when $|\nabla\phi(\rho)|$ exceeds $2\pi/\Delta\rho$, the maximum phase gradient that can be encoded on the SLM **60** with pixel size $\Delta\rho$. This problem is exacerbated when $\phi_0(\rho)$ itself has large gradients. In a preferred embodiment more complex trapping patterns without aberration are prepared. In particular, we use uncorrected volumetric imaging to illustrate the comparative advantages of the extended optical traps **100**.

The extended optical traps **100** have been projected in a time-shared sense by rapidly scanning a conventional optical tweezer along the trap's intended contour. A scanned trap has optical characteristics as good as a point-like optical tweezer, and an effective potential energy well that can be tailored by adjusting the instantaneous scanning rate. Kinematic effects due to the trap's motion can be minimized by scanning rapidly enough. For some applications, however, continuous illumination or the simplicity of an optical train with no scanning capabilities can be desirable.

Continuously illuminated line traps have been created by expanding an optical tweezer **125** along one direction (see FIG. **4A**). This can be achieved, for example, by introducing a cylindrical lens component such as by element **130** (see FIG. **1**) into the objective's input plane. Equivalently, a cylindrical-lens line tweezer can be implemented by encoding the function $\phi_c(\rho) = \pi z_0 \rho_x^2 / (\lambda f^2)$ on the SLM **60**. The result, shown in FIGS. **4A-4D** appears best useful in the plane of best focus, $z = z_0$, with the point-like tweezer having been extended to a line with nearly parabolic intensity and a nearly Gaussian phase profile. The three-dimensional reconstruction, however, reveals that the cylindrical lens component merely introduces a large amount of astigmatism into the beam of light **20**, creating a second focal line perpendicular to the first. This is problematic for some applications because the astigmatic beam's axial intensity gradients are far weaker than a conventional optical tweezer's. Consequently, cylindrical-lens line traps typically cannot localize objects against radiation pressure along the optical axis **90**.

Replacing the single cylindrical lens with a cylindrical Keplerian telescope for the element **130** eliminates the astig-

5

matism and thus creates a stable three-dimensional optical trap. Similarly, using the objective lens **50** to focus two interfering beams creates an interferometric optical trap capable of three-dimensional trapping. These approaches, however, offer little control over the extended traps' intensity profiles, and neither affords control over the phase profile.

Shape-phase holography provides absolute control over both the amplitude and phase profiles of an extended form of the optical trap **100** at the expense of diffraction efficiency. It also yields traps with optimized axial intensity gradients, suitable for three-dimensional trapping. If the line trap is characterized by an amplitude profile $\hat{u}(\rho_x)$ and a phase profile $\hat{p}(\rho_x)$ along the $\hat{\rho}_x$ direction in the objective's focal plane, then the field in the SLM plane is given from Eq. (1) as,

$$\psi(\rho) = u(\rho_x) \exp(ip(\rho_x)), \quad (5)$$

where the phase $p(\rho_x)$ is adjusted so that $u(\rho_x) \geq 0$. Shape-phase holography implements this one-dimensional complex wavefront profile as a two-dimensional phase-only hologram,

$$\varphi(\rho) = \begin{cases} p(\rho_x), & S(\rho) = 1 \\ q(\rho), & S(\rho) = 0 \end{cases}, \quad (6)$$

where the shape function $S(\rho)$ allocates a number of pixels along the row ρ_y , proportional to $u(\rho_x)$. One particularly effective choice is for $S(\rho)$ to select pixels randomly along each row in the appropriate relative numbers. The unassigned pixels then are given values $q(\rho)$ that redirect the excess light away from the intended line. Typical results are presented in FIG. 5A.

Unlike the cylindrical-lens trap, the holographic line trap **130** in FIGS. 5A-5D focuses as a conical wedge to a single diffraction-limited line in the objective's focal plane. Consequently, its transverse angle of convergence is comparable to that of an optimized point trap. This means that the holographic line trap **120** has comparably strong axial intensity gradients, which explains its ability to trap objects stably against radiation pressure in the z direction.

The line trap's transverse convergence does not depend strongly on the choice of intensity profile along the line. Its three-dimensional intensity distribution, however, is very sensitive to the phase profile along the line. Abrupt phase changes cause intensity fluctuations through Gibbs phenomenon. Smoother variations do not affect the intensity profile along the line, but can substantially restructure the beam. The line trap **120** created by the cylindrical lens element **130** for example, has a parabolic phase profile. Inserting this choice into Eq. (2) and calculating the associated shape-phase hologram with Eqs. (1) and (6) yields the same cylindrical lens phase profile. This observation opens the door to applications in which the phase profile along a line can be tuned to create a desired three-dimensional intensity distribution, or in which the measured three-dimensional intensity distribution can be used to assess the phase profile along the line. These applications will be discussed elsewhere.

The foregoing description of embodiments of the present invention have been presented for purposes of illustration and description. It is not intended to be exhaustive or to limit the present invention to the precise form disclosed, and modifications and variations are possible in light of the above teachings or may be acquired from practice of the present invention. The embodiments were chosen and described in order to explain the principles of the present invention and its practical application to enable one skilled in the art to utilize the

6

present invention in various embodiments, and with various modifications, as are suited to the particular use contemplated.

What is claimed is:

1. A method of manipulating objects using three dimensional optical traps, comprising the steps of:
 - providing an optical train;
 - providing a beam of light to the optical train;
 - applying a predetermined hologram to the beam of light to form an optical trap;
 - further applying a phase only hologram to establish a predetermined three dimensional optical trap configuration wherein the step of applying a phase only hologram includes having the optical train with a mirror operating on the beam of light to characterize a light field of the optical trap and the optical trap is translated relative to a fixed form of the mirror by including in the hologram a parabolic phase function; and
 - using the three dimensional optical trap to manipulate an object.
2. The method as defined in claim 1 wherein the phase only hologram is applied to selected ones of a plurality of the optical trap, the step including modifying wavefronts of the optical trap.
3. The method as defined in claim 1 wherein the parabolic phase function comprises,

$$\varphi_z(\rho) = -\frac{\pi\rho^2 z}{\lambda f^2}, \quad (3)$$

where,

- ϕ =distance within the hologram;
- z =distance along an optical axis of the optical train;
- λ =wavelength of the light;
- f =objective lens focal length.

4. The method as defined in claim 1 wherein computer software executed by a computer creates the hologram for translating the optical trap.
5. The method as defined in claim 1 further including the step of passing the beam of light through an objective lens of the optical train and applying a phase profile to the optical trap, thereby enabling the plurality of optical traps to organize selected objects along an optical axis of the optical train.
6. The method as defined in claim 5 wherein the phase profile comprises,

$$\varphi_a(\rho) = \frac{a}{\sqrt{2}}(6x^4 - 6x^2 + 1),$$

thereby correcting for spherical aberration,

where x is distance in a plane perpendicular to the optical axis.

7. The method as defined in claim 1 further including the step of forming a single optical trap and rapidly scanning the optical trap along the predetermined three dimensional optical trap configuration.
8. The method as defined in claim 1 further including the step of introducing an objective lens in the optical train and introducing a cylindrical lens component into an input plane of the objective lens.
9. The method as defined in claim 1 wherein the step of applying a predetermined hologram includes introducing a cylindrical-lens line tweezer component into the hologram.

7

10. The method as defined in claim 9 wherein the predetermined hologram includes the function $\phi_c(\rho)=\phi_c(\rho)=\pi z_0 \rho_x^2 / (\lambda f^2)$.

11. The method as defined in claim 1 further including in the optical train a Keplerian telescope for eliminating astigmatism, thereby creating a stable three dimensional optical trap.

12. The method as defined in claim 1 wherein the optical trap comprises a hologram constructed of,

- a. an amplitude profile $\tilde{m}(\rho_x)$,
- b. a phase profile $\tilde{p}(\rho_x)$ with an objective focal plane direction $\hat{\rho}_x$.

8

13. The method as defined in claim 11 wherein the optical train includes an SLM having an associated plane and the field in the associated plane is given by, $\psi(\rho)=u(\rho_x)\exp(ip(\rho_x))$.

14. The method as defined in claim 1 wherein the phase only hologram comprises,

$$\varphi(\rho) = \begin{cases} p(\rho_x), & S(\rho) = 1 \\ q(\rho), & S(\rho) = 0 \end{cases}$$

* * * * *